

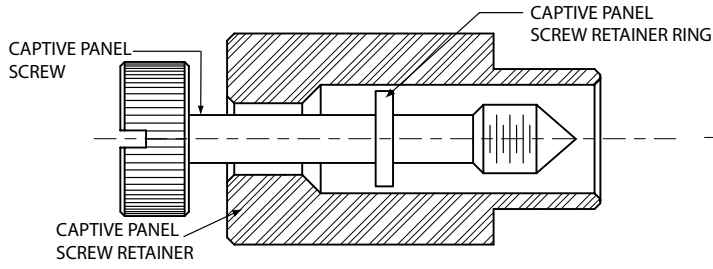

PANEL SCREW RETAINER SPRINGS AND RETAINER RINGS

TYPE C



TYPE D

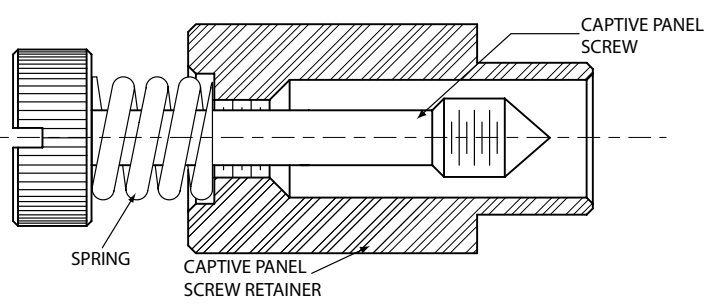

TYPE E

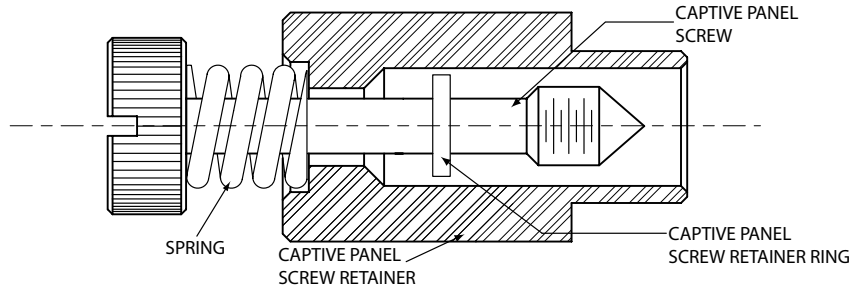

STAINLESS STEEL SPRINGS AND RETAINER RINGS

PART NUMBER R055

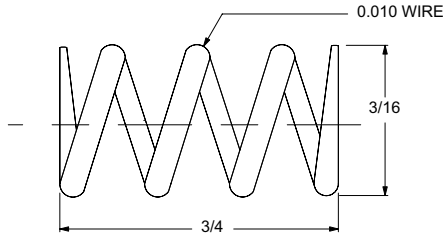

PART NUMBER R056

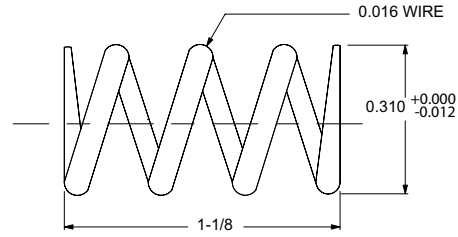

RETAINER RING

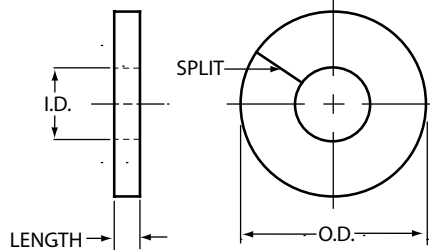
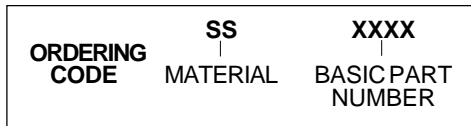

RETAINER RING SIZES

BASIC PART NUMBER	THREAD	O.D. ±0.003	I.D. ±0.003	LENGTH ±0.003
R057	4-40	0.171	0.093	0.010
R058	6-32	0.171	0.112	0.010
R059	8-32	0.312	0.146	0.012
R060	10-24	0.312	0.166	0.012
R061	10-32	0.312	0.166	0.012
R062	12-24	0.312	0.190	0.012
R063	1/4-20	0.312	0.204	0.012
R064	1/4-28	0.312	0.214	0.012

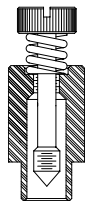
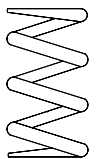

F36